

# MOE'S

h o m e c o l l e c t i o n

## ASSEMBLY INSTRUCTIONS.

POST COFFEE TABLE WHITE OAK

**BC-1096-18**

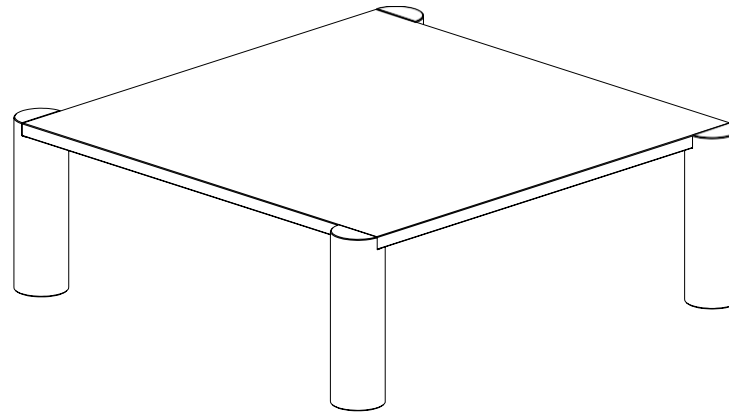

THANK YOU FOR YOUR PURCHASE!

## PART LIST

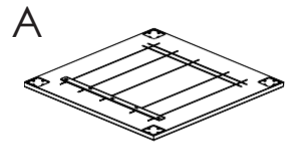

Top Table = 1pc

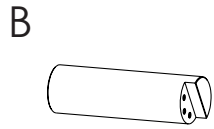

Leg = 4pcs

## HARDWARE LIST

1. Bolt

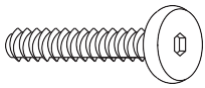

M6x20mm

24pcs

2. Spring washer



M6.5x13mm

12pcs

3. Flat washer

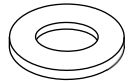

M6.5x18mm

12pcs

4. Allen key



1 pc

5. Mounting Plate metal

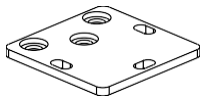

4pcs

## NOTES.

Thank you for purchasing this quality product! Be sure to check all packing material carefully for small part that may have come loose inside the carton during shipping.

## CAUTION:

The item is heavy, assembly should be performed by two people.

*Step 1*

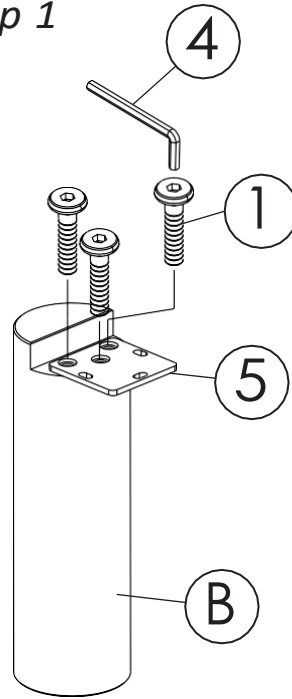

*Step 2*

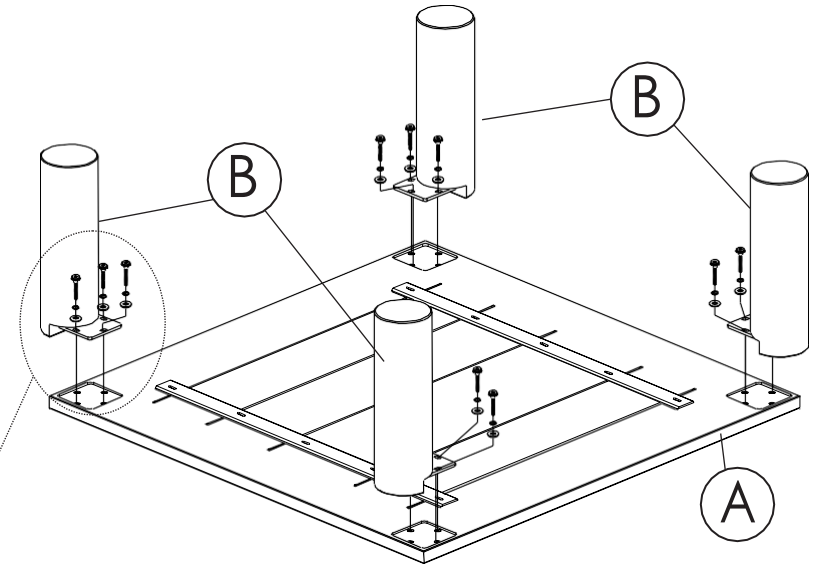
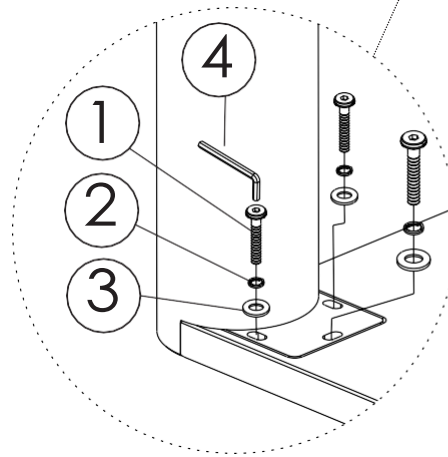

OPTION 2

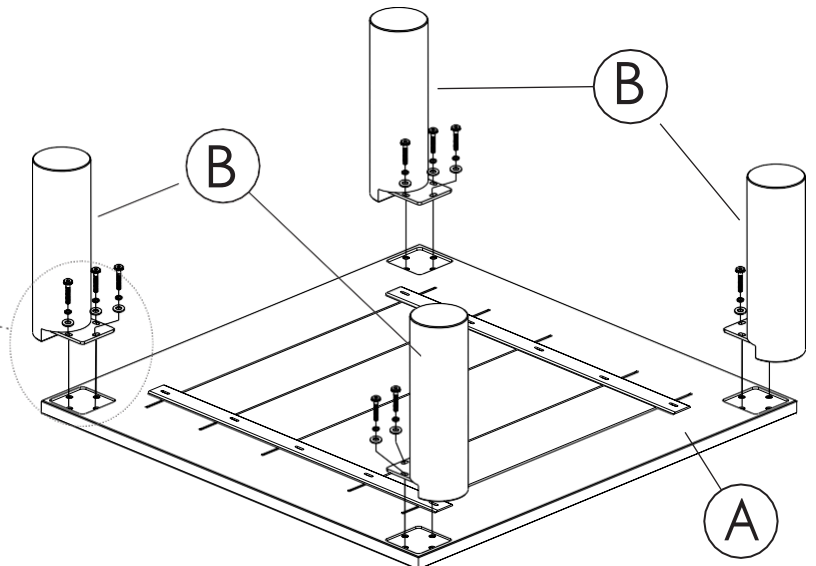

OPTION 1