



# EH-1039-18

## HARDWARE LIST

NO	B	C	D	E	F
TYPE	 8*50mm	 8*5mm	 8*2mm	 5*64mm	 14*60mm
QTY	4PCS	4PCS	4PCS	1PC	1PC

### STEP 1

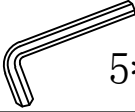
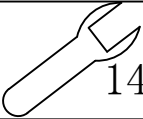
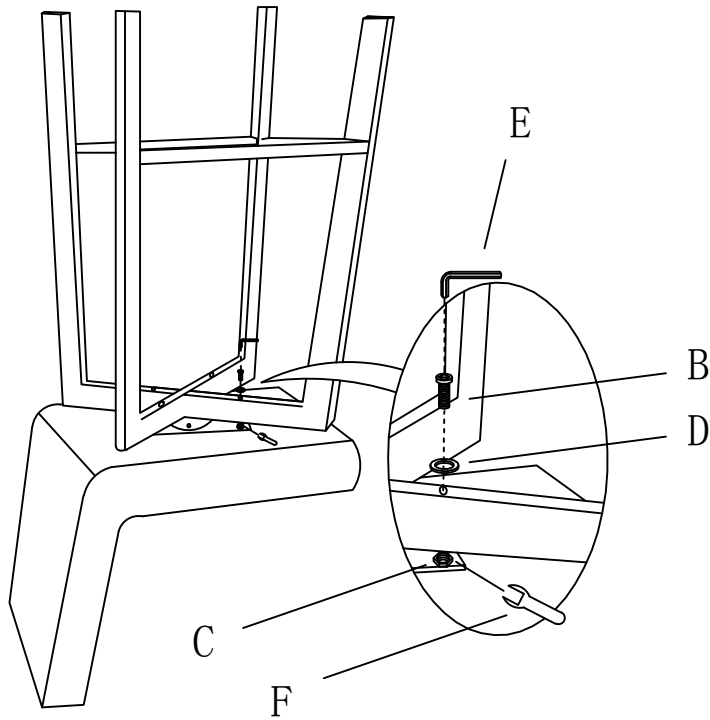

### FINISH

